

# G-9

## UPRIGHT COOLER

### G-Series Coolers

## FEATURES

- Exterior Dimensions (WDH): 19.875" x 21.75" x 63.625"
- Internal Volume: 7.2 ft<sup>3</sup>
- Dynamic LED Lighting In Door Provides Enhanced Product Illumination While Greatly Reducing Energy Consumption
- Forced Air Refrigeration System For Fast Product Temperature Pull Down
- High Impact Side Panel Graphics
- High Density Environmentally Friendly Insulation
- Utilizes Climate-Friendly Natural Refrigerant
- 4 Fully Adjustable Powder-Coated Metal Shelves
- Double-Paned, Low "E", Self-Closing Glass Door
- LED Interior Lighting
- Durable Pre-Painted Steel Cabinet and Heavy Duty Inner Liner
- Adjustable Temperature Control
- 9' Heavy Duty Power Cord

## CERTIFICATIONS

### 110v

- UL471
- NSF/ANSI-7: Type 2 Display Refrigerator
- ENERGY STAR<sup>®</sup> Qualified



# G-9

## UPRIGHT COOLER

### G-Series Coolers

#### TECH SPECS

Refrigerant	R290
Amps	1.7
Volts/Hz	110-120V/60Hz
Compressor HP	1/5

#### SHIPPING SPECS

Gross Weight	.....187 lbs
Net Weight	.....158 lbs
Carton Dims (WDH)	.....20"x23"x69.5"
Units per Pallet	.....1
Shipping Options:	
Floor Loaded	.....20' ~ 44
	.....40'HQ ~ 88
	.....53' ~ 120

#### DIMENSIONS





Exterior: 19.875"W x 21.75"D x 63.625"H

Interior: 16.25"W x 15.75"D x 46.25"H

Shelf: 15.25"W x 13"D

Internal Volume: 7.2 ft<sup>3</sup>

#### PACKOUT CAPACITIES

	Facings	Deep	Total Capacity	Total Rows
 6 Shelves + Base	6	x 5	= 210*	7
 Top	6	x 2	= 162*	6
 4 Shelves + Base	6	x 5	= 162*	6
 3 Shelves	5	x 4	= 85**	4
 Base	5	x 5	= 85**	4

\*Additional shelves, beyond what is supplied with the cooler, may be required to achieve this maximum pack-out.  
 \*\* 20oz pack-outs may vary depending on package size.



#### EXTERIOR DIMENSIONS

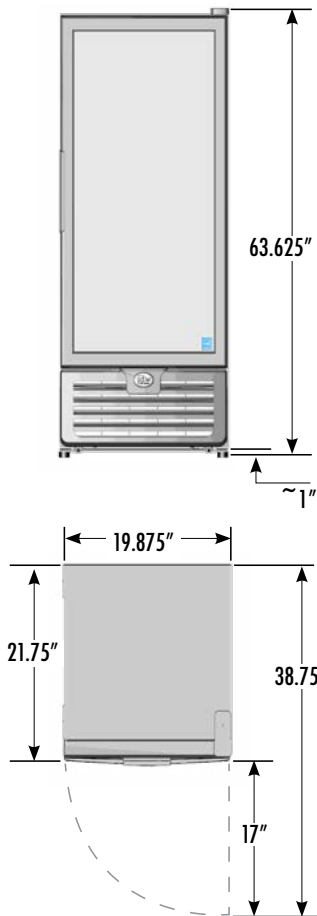

#### INTERIOR DIMENSIONS

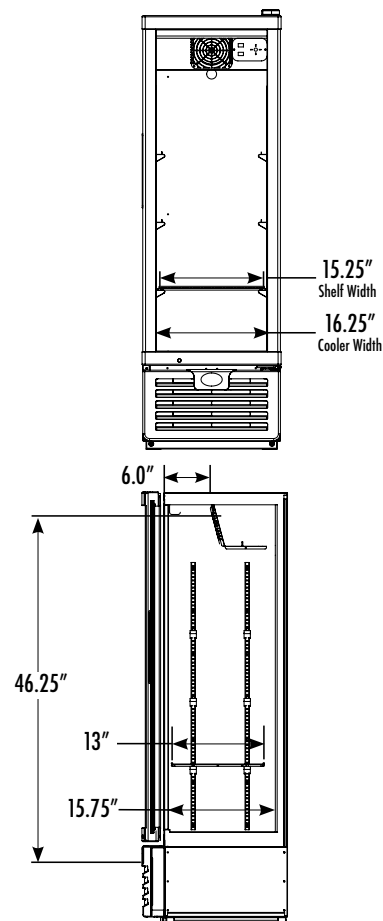

8825 Boston Place, Rancho Cucamonga CA 91730 | Toll: 877.307.2665 | Office: 909.447.8254 | Fax: 909.305.8756 | www.idw.global

The specifications contained herein are for illustrative marketing purposes only and are not intended to be relied upon in whole or in part. All creative works are the sole property of IDW, Inc. Any reproduction in part or as a whole without written permission from IDW, Inc. is prohibited.