

## RECHARGE COLD MERCHANDISER

### G-Series Coolers

## FEATURES

- Exterior Dimensions: 22"W x 17.5"D x 39.375"H
- Internal Volume: 2.3ft<sup>3</sup>
- Expand Your Cold Drink Availability, No Longer Are You Restricted by the Availability of Electric Power
- Unique Refrigeration System Designed for Use in Multiple Operating Environments Where Electricity is Not Available
- Designed to Maintain Ice Cold Beverage Temperatures for 12 Hours or More
- Tested to Meet the Most Stringent Performance Guidelines \*
- Utilizes Climate-Friendly Natural Refrigerant
- Stimulate Impulse Sales in Any High Traffic Location:
  - Convenience Retail
  - Petroleum
  - Concessions/Stadium
  - Cafeteria
  - Special Events
  - Kiosks
- Heavy Duty Casters for Mobility and Flexibility of Placement at Retail
- Quick-Change Two Sided Graphic Panels
- CFC-Free Insulation
- 9' Cord with Cord Management System



Covered by one or more claims of U.S. Patent  
Nos. 8,215,125 and/or 9,038,412

## CERTIFICATIONS

### 110v

- UL471
- NSF/ANSI-7: Beverage Cooler
- ENERGY STAR<sup>®</sup> Qualified



\* RCM will maintain average 35-40°F drink temperature in a 90°F environment for 12 hours without power. Actual performance may vary depending on operating environment.



## TECH SPECS

Refrigerant	R600a	R134a
Amps	2.2	1.8
Volts/Hz	110-120V/60Hz	110-120V/60Hz
Compressor HP	1/8	1/6

## SHIPPING SPECS

Gross Weight	.....128 lbs
Net Weight	.....119 lbs
Carton Dims (WDH)	.....24.25"x19"x44"
Units per Pallet	.....8
Shipping Options:	
Floor Loaded	.....20' ~ 90
	40'HQ ~ 182
	53' ~ 208



## DIMENSIONS

Exterior: 22"W x 17.5"D x 39.375"H

Basket: 14.83"W x 8.9"D x 23.59"H

Internal Volume: 2.3 ft<sup>3</sup>

## PACKOUT CAPACITIES

	Total Capacity
	70-72
	64
	42**

\*\* 20oz pack-outs may vary depending on package size.

# RECHARGE COLD MERCHANDISER

## G-Series Coolers



Covered by one or more claims of U.S. Patent Nos. 8,215,125 and/or 9,038,412

### EXTERIOR DIMENSIONS

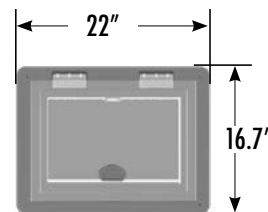

### INTERIOR DIMENSIONS

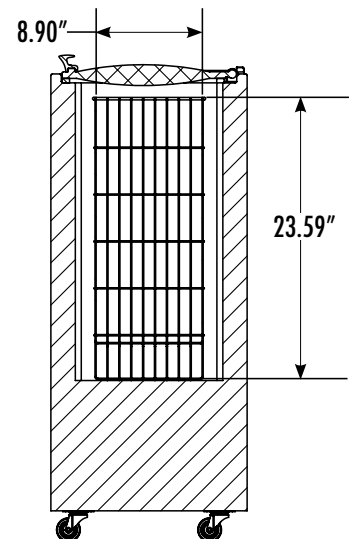
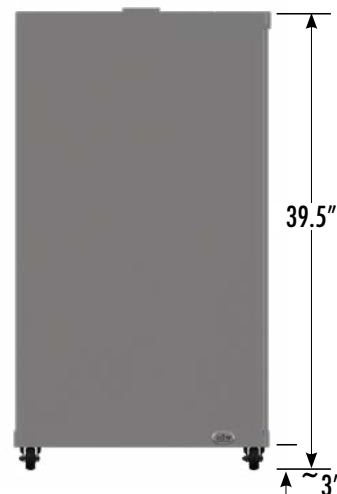
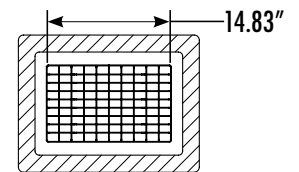

\* For best performance allow 24 hours for initial charge and load with prechilled products.

\*\* RCM will maintain average 35-40°F drink temperature in a 90°F environment for 12 hours without power. Actual performance may vary depending on operating environment.

Covered by one or more claims of U.S. Patent Nos. 8,215,125 and/or 9,038,412



## RECHARGE COLD MERCHANDISER

### G-Series Coolers

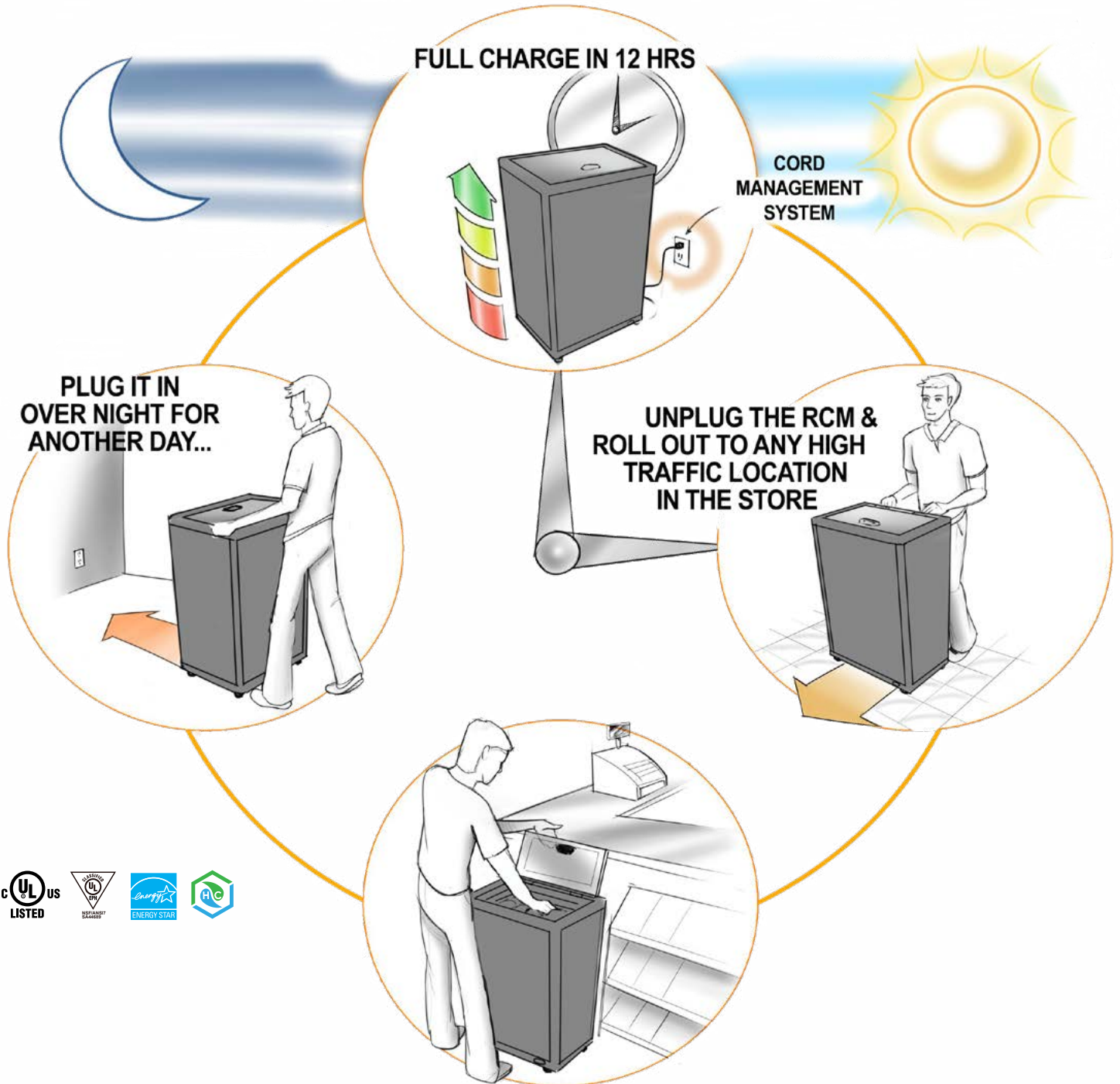

**STAYS ICE COLD FOR 12+ HRS.  
ELECTRIC POWER NOT REQUIRED**



8825 Boston Place, Rancho Cucamonga CA 91730 | Toll: 877.307.2665 | Office: 909.447.8254 | Fax: 909.305.8756 | [www.idw.global](http://www.idw.global)

The specifications contained herein are for illustrative marketing purposes only and are not intended to be relied upon in whole or in part. All creative works are the sole property of IDW, Inc. Any reproduction in part or as a whole without written permission from IDW, Inc. is prohibited.



## RECHARGE COLD MERCHANDISER

### G-Series Coolers

#### INSTALLATION AND OPERATION

1. Connect the empty RCM<sup>2</sup> to a Power Source for 12+ hours.
2. After the empty cooler has been operating for an initial period of 12 hours, the unit can then be loaded with products\*.
3. The cooler can then be unplugged and rolled to any high traffic retail location for up to 12 hours. After 12 hours the unit must be plugged in again for an additional 12 hours. (The Re-Charge cycle)

It is important to understand that the Re-Charge Cold Merchandiser (RCM<sup>2</sup>) is designed to operate differently than typical beverage coolers. Typical coolers circulate the cold the air inside the cabinet to chill the beverages. The RCM<sup>2</sup> does not follow this principle. The RCM<sup>2</sup> freezes liquid filled coolant packs within the interior walls of the cabinet. It is important that these coolant packs are completely frozen to ensure that the beverages will be kept at a cold temperature for the maximum amount of time while the unit is unplugged and moved to the desired location. The initial time required to freeze these coolant packs can be between 12 and 24 hours depending on the operating environment.

*\*For best results, on initial set-up we recommend the RCM<sup>2</sup> is allowed 24 hours to completely freeze the coolant packs. Following this initial 24 hour "charge" the subsequent "recharge" time will be much less. By following this extended initial freezing period, you will be ensuring that consumers are receiving the coldest possible beverage for the best possible extended time while the RCM<sup>2</sup> is unplugged.*



Covered by one or more claims of U.S. Patent  
Nos. 8,215,125 and/or 9,038,412

