

# G-2.5/GS-2.5

## COUNTERTOP COOLER

G-Series Coolers

### FEATURES

- Exterior Dimensions (WDH): 18.25" x 20.75" x 27.75"
- Internal Volume: 2.45 ft<sup>3</sup>
- Dynamic LED Lighting In Door Provides Enhanced Product Illumination While Greatly Reducing Energy Consumption
- Forced Air Refrigeration System For Fast Product Temperature Pull Down
- High Impact Side Panel Graphics
- High Density Environmentally Friendly Insulation
- Utilizes Climate-Friendly Natural Refrigerant
- 1 Adjustable Powder-Coated Metal Shelves
- Double-paned, Low "E", Self-Closing Glass Door
- LED Interior Lighting
- Durable Pre-painted Steel Cabinet and Heavy Duty Inner Liner
- Adjustable Temperature Control
- 9' Heavy Duty Power Cord

### CERTIFICATIONS

#### 110v

- UL471
- NSF-7, Type 2 Display Refrigerator
- ENERGY STAR<sup>®</sup> Qualified



Available with  
High Visibility LED  
Illuminated Logo  
in Door



## TECH SPECS

Refrigerant	R600a
Amps	.78A
Volts/Hz	110-120V/60Hz
Compressor HP	1/6

## SHIPPING SPECS

Gross Weight	83 lbs
Net Weight	77 lbs
Carton Dims (WDH)	20.25"x22.25"x29.5"
Units per Pallet	12
Shipping Options:	
Floor Loaded	20' ~ 132
	40'HQ ~ 276
	53' ~ 312

## DIMENSIONS



Exterior: 18.25"W x 20.75"D x 27.75"H

Interior: 15.125"W x 12"D x 23"H

Shelf: 14.25"W x 11.25"D

Internal Volume: 2.45 ft<sup>3</sup>

## PACKOUT CAPACITIES

		Facings	Deep	Total Capacity	Total Rows
	2 Shelves	5	x 4	= 55*	3
	Base	5	x 3		
	2 Shelves	5	x 4	= 55*	3
	Base	5	x 3		
	1 Shelf	5	x 4	= 35**	2
	Base	5	x 3		

\* Additional shelves, beyond what is supplied with the cooler, may be required to achieve this maximum pack-out.  
 \*\* 20oz pack-outs may vary depending on package size.

# G-2.5/GS-2.5

## COUNTERTOP COOLER

G-Series Coolers



EXTERIOR DIMENSIONS

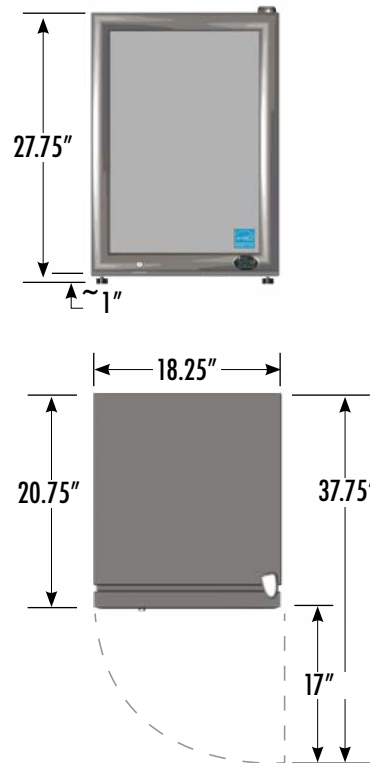

INTERIOR DIMENSIONS

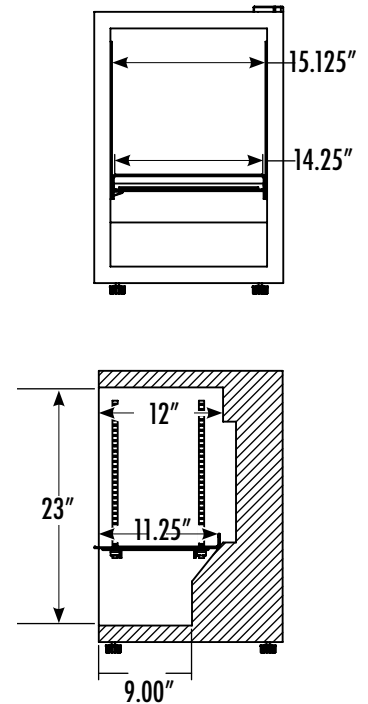

8825 Boston Place, Rancho Cucamonga CA 91730 | Toll: 877.307.2665 | Office: 909.447.8254 | Fax: 909.305.8756 | www.idw.global

The specifications contained herein are for illustrative marketing purposes only and are not intended to be relied upon in whole or in part. All creative works are the sole property of IDW, Inc. Any reproduction in part or as a whole without written permission from IDW, Inc. is prohibited.