

GS-2.5

COUNTERTOP COOLER

G-Series Coolers

FEATURES

- Exterior Dimensions (WDH): 463 x 514 x 705 mm
- Internal Volume: 69.37 L
- Dynamic LED Lighting In Door Provides Enhanced Product Illumination While Greatly Reducing Energy Consumption
- Forced Air Refrigeration System For Fast Product Temperature Pull Down
- High Impact Side Panel Graphics
- High Density Environmentally Friendly Insulation
- Utilizes Climate-Friendly Natural Refrigerant
- 1 Adjustable Powder-Coated Metal Shelves
- Double-Paneled, Low "E", Self-Closing Glass Door
- LED Interior Lighting
- Durable Pre-Painted Steel Cabinet and Heavy Duty Inner Liner
- Adjustable Temperature Control
- 9' Heavy Duty Power Cord

CERTIFICATIONS

220v

- ROHS
- EMC (GS2.5, R134a)
- CB Scheme (GS2.5, R134a)



High Visibility LED
Illuminated Logo
in Door



8825 Boston Place, Rancho Cucamonga CA 91730 | Toll: 877.307.2665 | Office: 909.447.8254 | Fax: 909.305.8756 | www.idw.global

The specifications contained herein are for illustrative marketing purposes only and are not intended to be relied upon in whole or in part. All creative works are the sole property of IDW, Inc. Any reproduction in part or as a whole without written permission from IDW, Inc. is prohibited.

GS-2.5

COUNTERTOP COOLER

G-Series Coolers

TECH SPECS

Refrigerant	R600a	R134a
Amps	.4A	.9A
Volts/Hz	220-240V/50Hz	220-240V/50Hz
Compressor HP	1/6	1/10



SHIPPING SPECS

Gross Weight	38 kg
Net Weight	35 kg
Carton Dims (WDH).....	515x564x750mm
Units per Pallet	12
Shipping Options:	
Pallet Loaded.....	20' ~ 88
	40'HQ ~ 276

DIMENSIONS

Exterior (WDH): 463 x 514 x 705 mm
 Interior (WDH): 384 x 305 x 584 mm
 Shelf (WD): 362 x 286 mm
 Internal Volume: 69.37 L

PACKOUT CAPACITIES

	Facings	Deep	Total Capacity	Total Rows
	2 Shelves	5 x 4	= 55*	3
	Base	5 x 3		
	1 Shelf	5 x 4	= 35	2
	Base	5 x 3		

* Additional shelves, beyond what is supplied with the cooler, may be required to achieve this maximum pack-out.



EXTERIOR DIMENSIONS

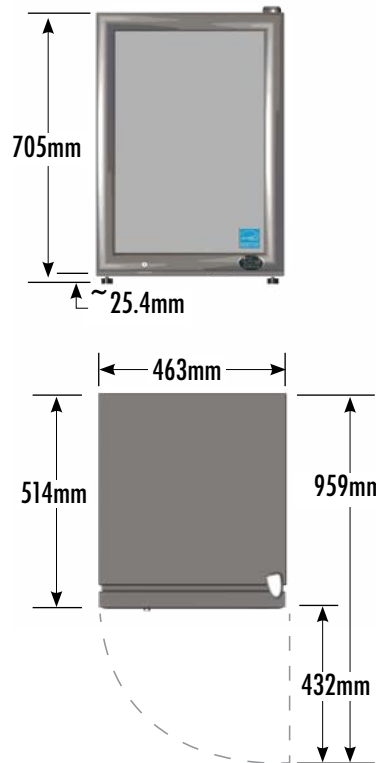

INTERIOR DIMENSIONS

